

# 5504-12-08-SS

Stainless Steel, SAE J514 Pipe 90° Female Elbow, 3/4" Female NPTF x 1/2" Female NPTF

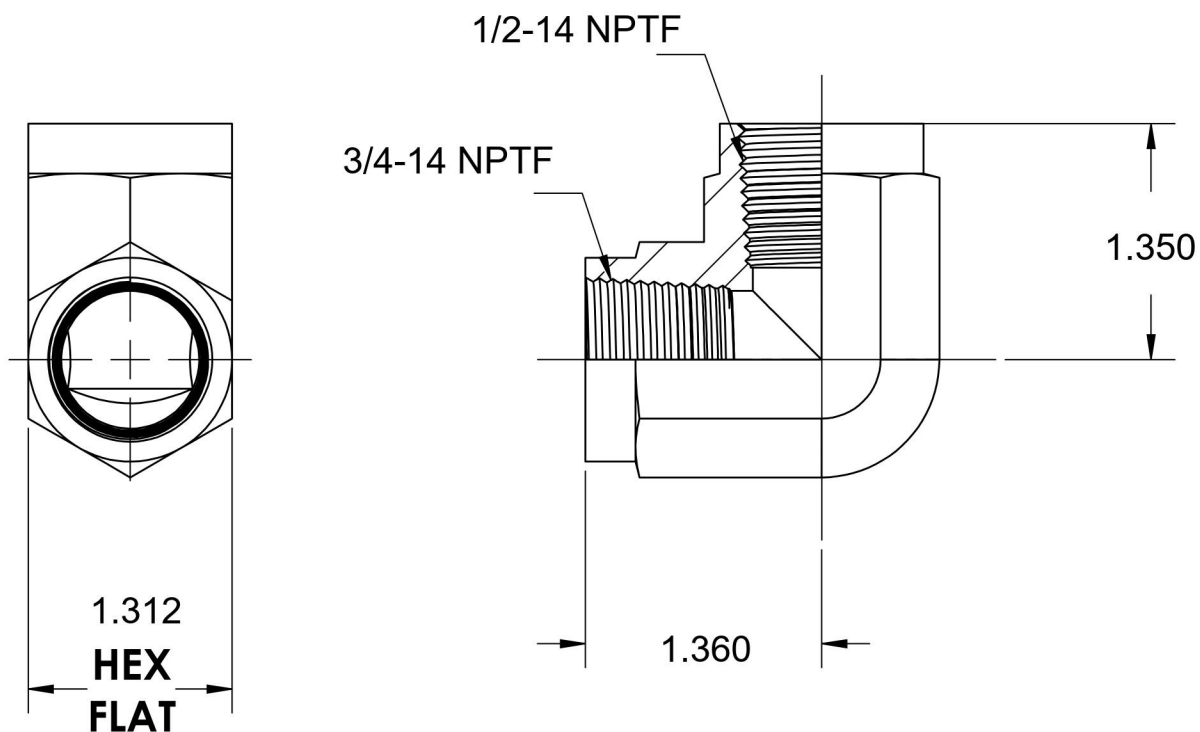

6701 Cochran Road  
Solon, Ohio 44139  
Phone: (440) 248-1880  
Toll Free: 1-888-331-1523

#### Temperature Rating

-425°F to 1200°F

#### Pressure Rating

3000 psi

#### Material

316/316L Stainless Steel

#### Finish

Passivated

#### Industry Standards

SAE J514, SAE J476

#### Series

5504-SS

#### Series Description

SAE J514 Pipe 90° Female Elbow