

D2408-L42-X

Steel, DIN 2353 Plug, Light 42mm Tube OD, Body Only

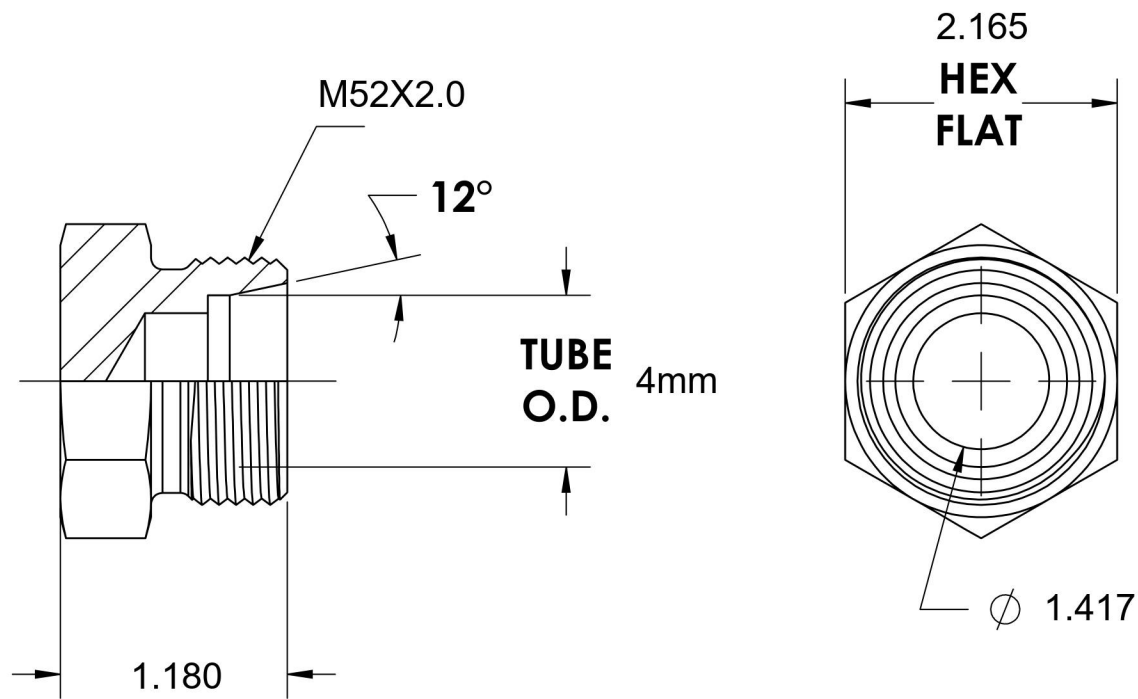
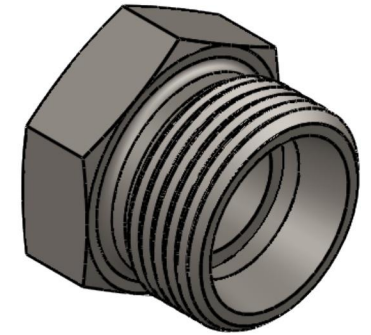

6701 Cochran Road
Solon, Ohio 44139
Phone: (440) 248-1880
Toll Free: 1-888-331-1523

Temperature Rating -65°F to 500°F	Material C22 Steel	Industry Standards DIN 2353, ISO 8434-1	Series D2408-X
Pressure Rating 3626 psi	Finish Zinc Nickel		Series Description DIN 2353 Flareless Tube Plug, Body Only