

2502-04-04-FG

Steel, SAE J514 37° Flare 90° Female Elbow, 1/4" Male JIC x 1/4" Female NPTF

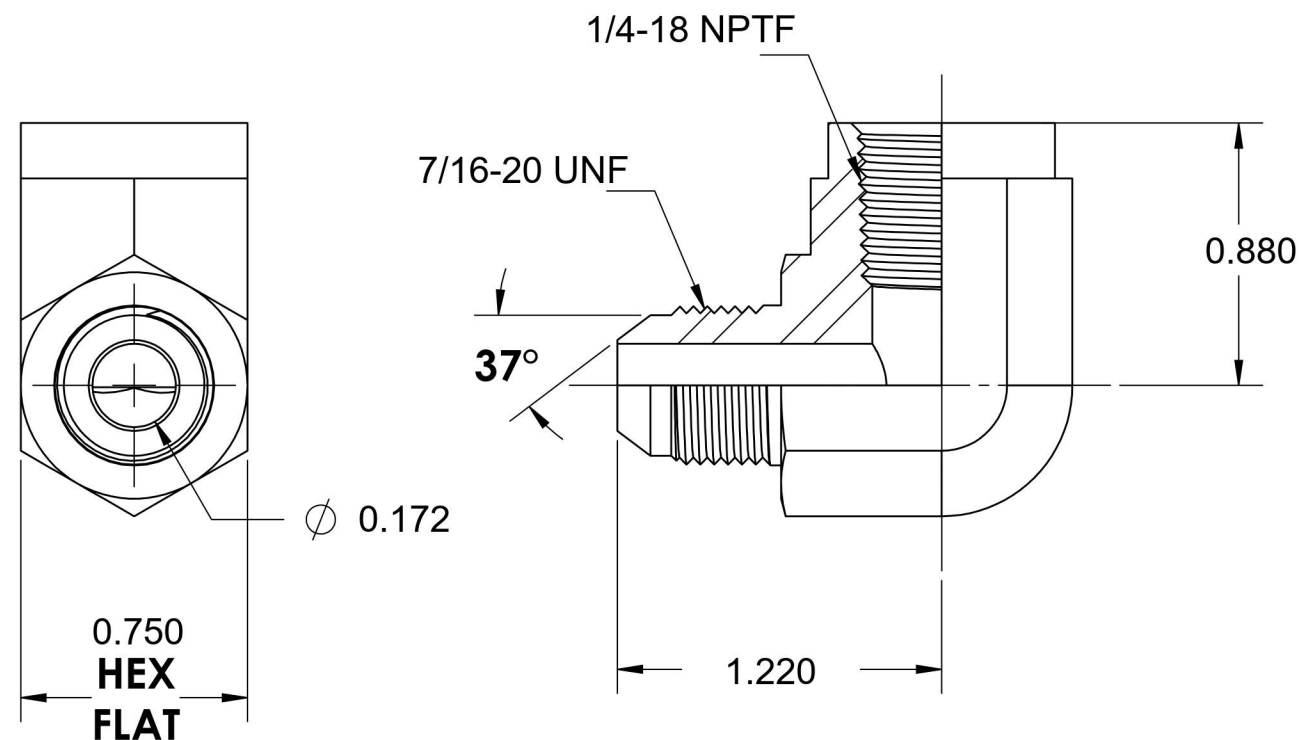

6701 Cochran Road
Solon, Ohio 44139
Phone: (440) 248-1880
Toll Free: 1-888-331-1523

Temperature Rating

-65°F to 500°F

Pressure Rating

5000 psi

Material

C1045 Steel

Finish

Trivalent Zinc

Industry Standards

SAE J514 , SAE J476
ASTM B633

Series

2502-FG

Series Description

SAE J514 37° Flare
90° Female Elbow