

# 2605-06-02-06-FG

Steel, SAE J514 37° Flare Male Run Tee, 3/8" Male JIC x 1/8" Male NPTF 30° x 3/8" Male JIC

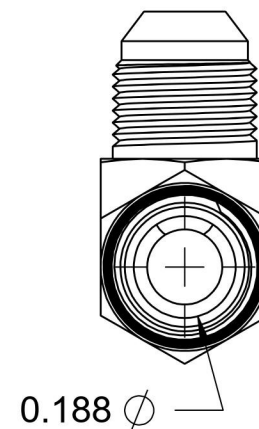
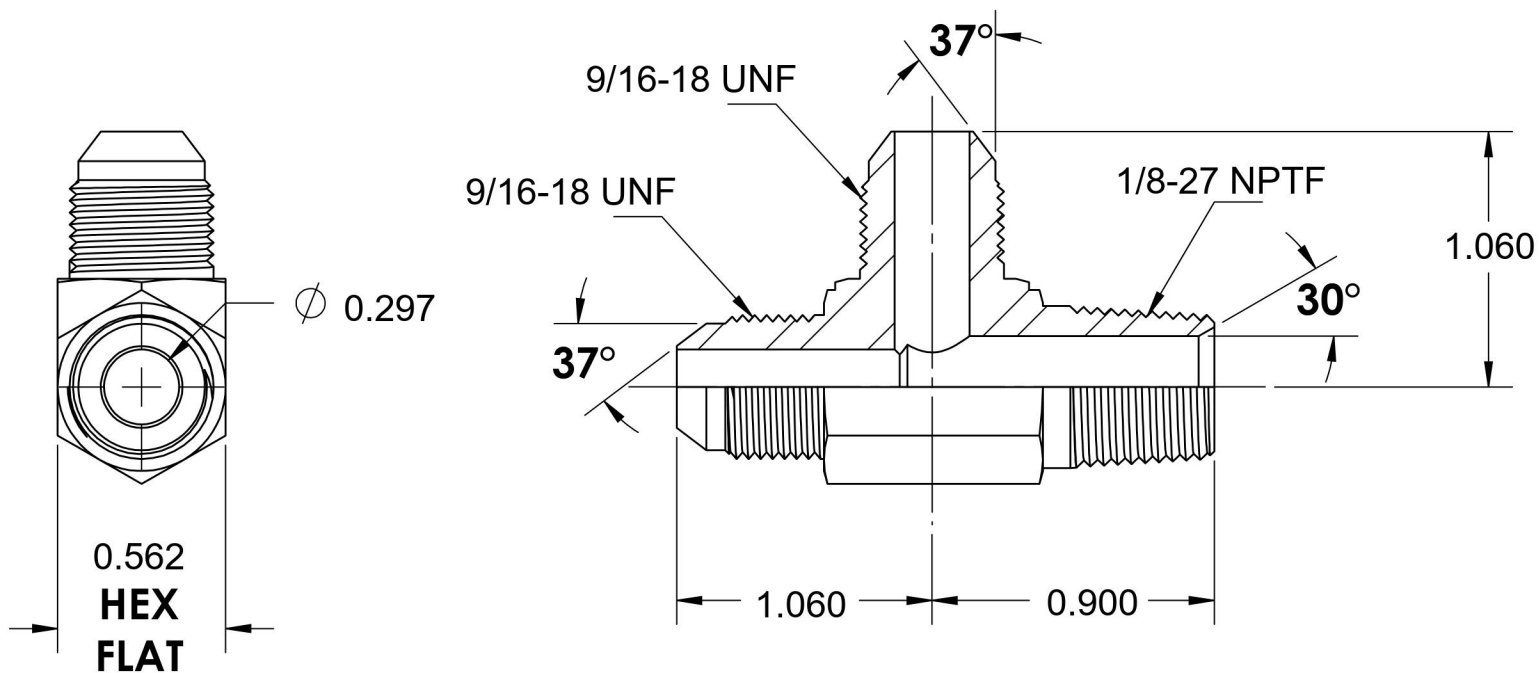
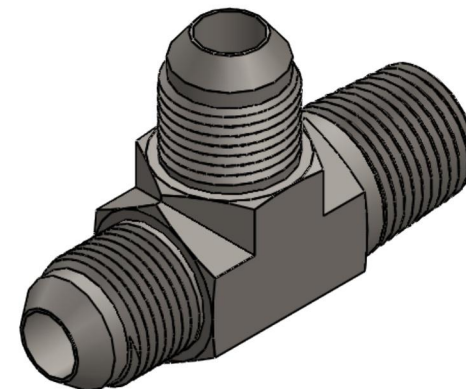
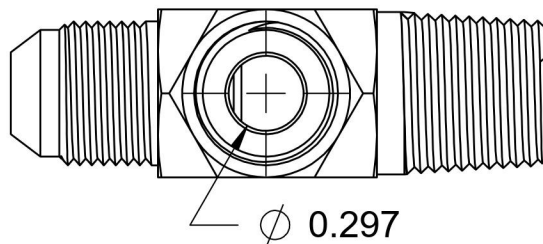

6701 Cochran Road  
Solon, Ohio 44139  
Phone: (440) 248-1880  
Toll Free: 1-888-331-1523

**Temperature Rating**

-65°F to 500°F

**Pressure Rating**

6000 psi

**Material**

C1045 Steel

**Finish**

Trivalent Zinc

**Industry Standards**

SAE J514 , SAE J476  
ASTM B633

**Series**

2605-FG

**Series Description**

SAE J514 37° Flare Male Run Tee