

FS6400-L-12-10-O

Steel, SAE J1453 O-Ring Face Seal Long Port Connector, 3/4" Male ORFS x 7/8-14 Male ORB

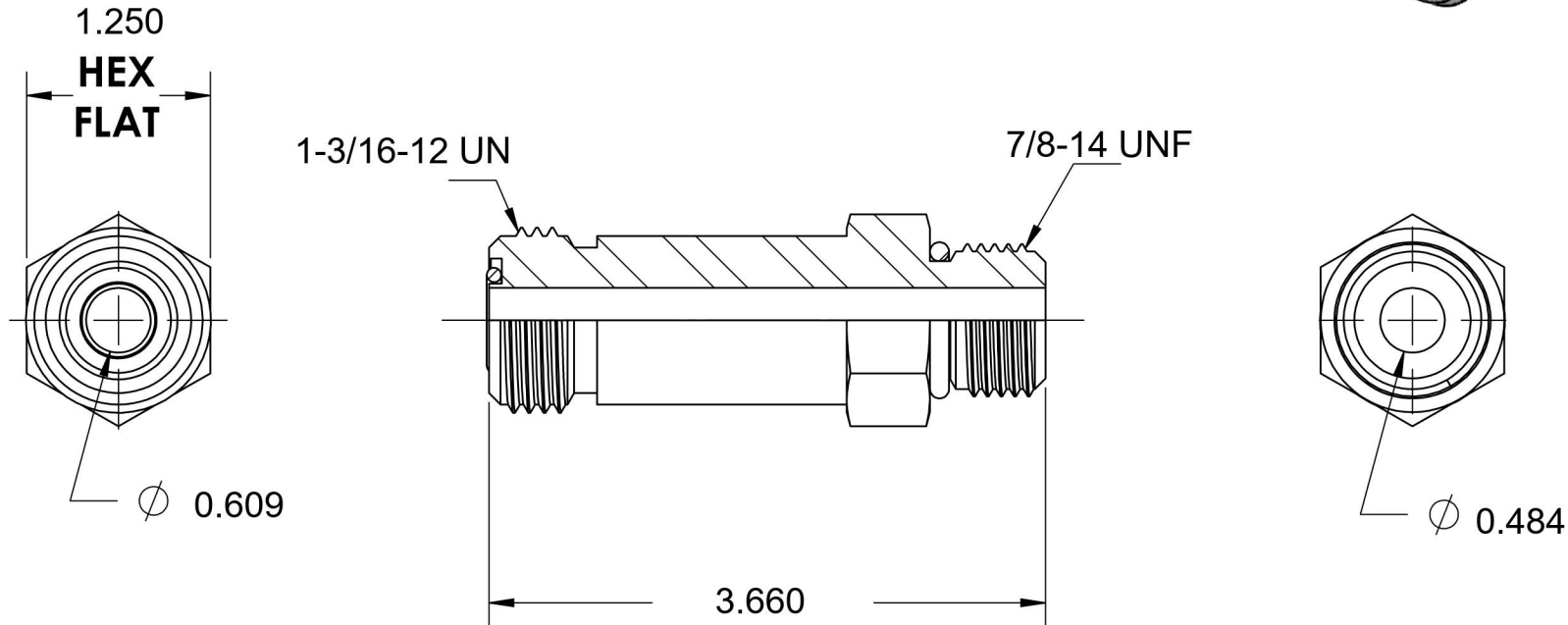
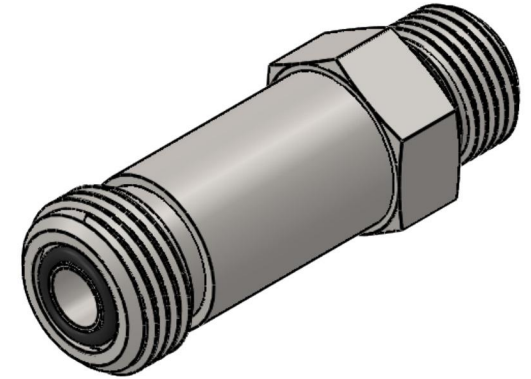

6701 Cochran Road
Solon, Ohio 44139
Phone: (440) 248-1880
Toll Free: 1-888-331-1523

Temperature Rating

-40°F to 250°F

Pressure Rating

6000 psi

Material

C1045/12L14 Steel

Finish

Trivalent Zinc

Industry Standards

SAE J1453, SAE J1926-2
SAE J515, ASTM B633

Series

FS6400-L-O

Series Description

SAE J1453 O-Ring Face Seal
Long Port Connector