

D2408-S25-SS-X

Stainless Steel, DIN 2353 Plug, Heavy 25mm Tube OD, Body Only

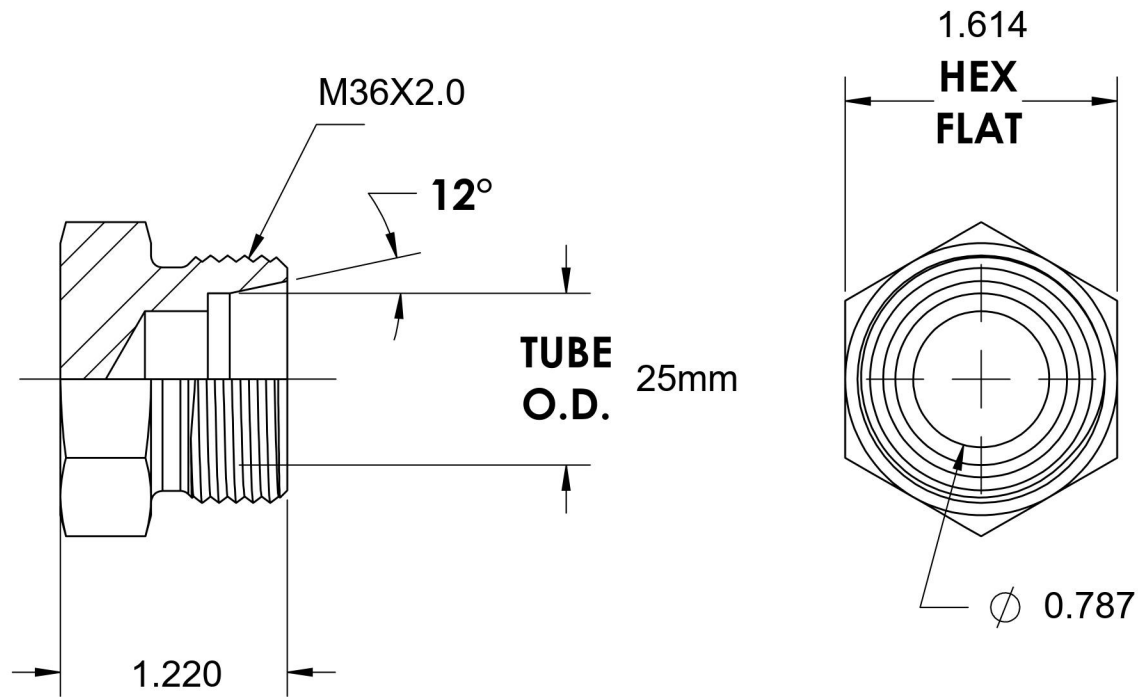
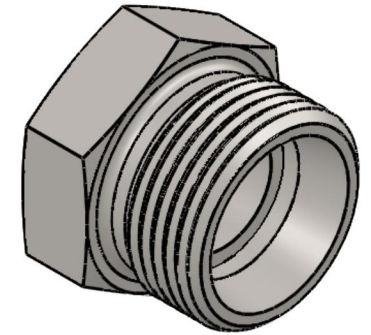

6701 Cochran Road
Solon, Ohio 44139
Phone: (440) 248-1880
Toll Free: 1-888-331-1523

Temperature Rating	Material	Industry Standards	Series
-425°F to 1200°F	316Ti Stainless Steel	DIN 2353, ISO 8434-1	D2408-SS-X
Pressure Rating	Finish		Series Description
6092 psi	Passivated		DIN 2353 Flareless Tube Plug, Body Only