

6900-05-08-O

Steel, SAE J514 NPSM Swivel Port Connector, 1/2-20 Male ORB x 1/2" Female NPSM Swivel

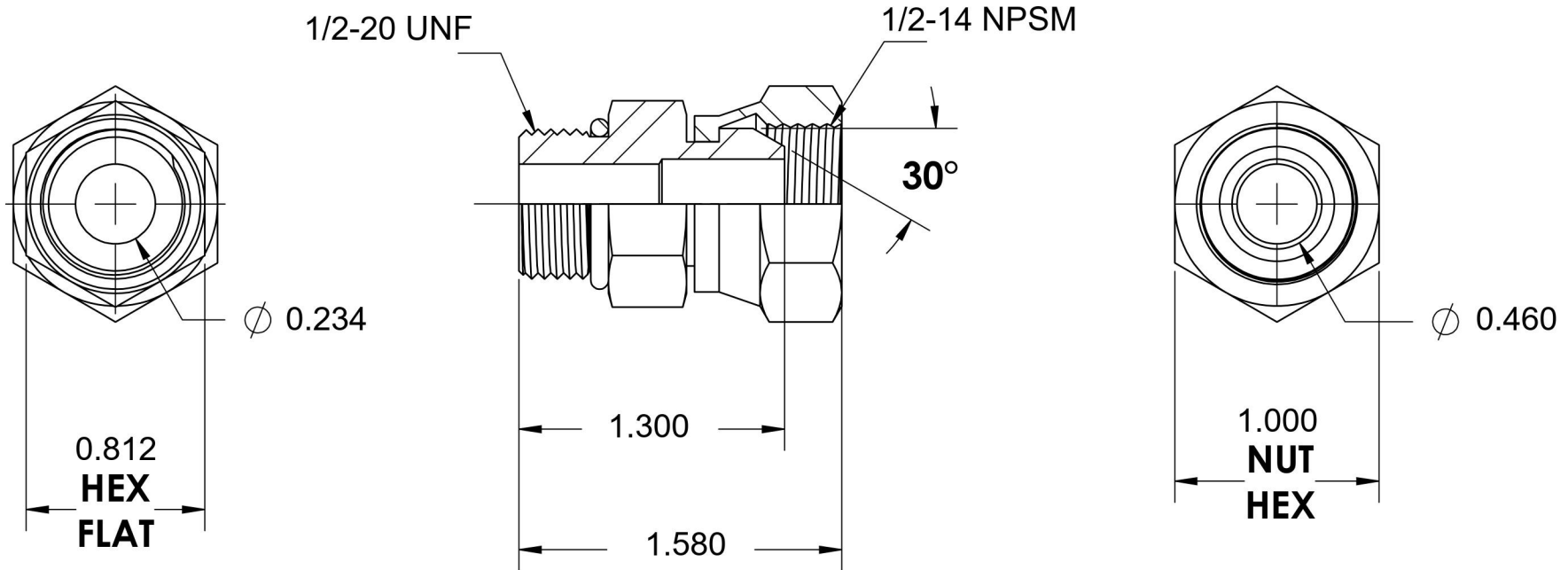
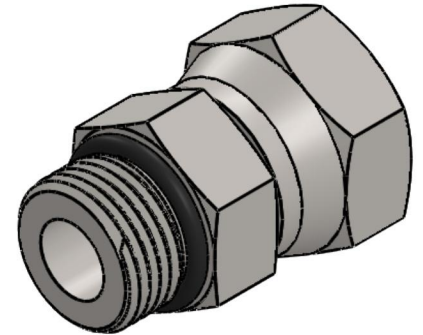

6701 Cochran Road
Solon, Ohio 44139
Phone: (440) 248-1880
Toll Free: 1-888-331-1523

Temperature Rating

-40°F to 250°F

Pressure Rating

5000 psi

Material

C1045/12L14 Steel

Finish

Trivalent Zinc

Industry Standards

SAE J514, SAE J476
SAE J1926-3, SAE J515
ASTM B633

Series

6900-O

Series Description

SAE J514 NPSM Swivel Port Connector