

2605-06-08-06-FG

Steel, SAE J514 37° Flare Male Run Tee, 3/8" Male JIC x 1/2" Male NPTF 30° x 3/8" Male JIC

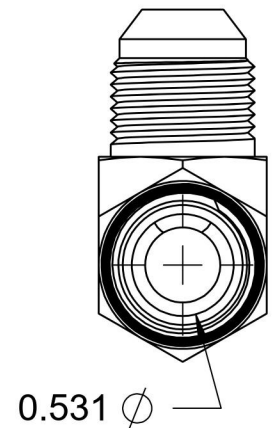
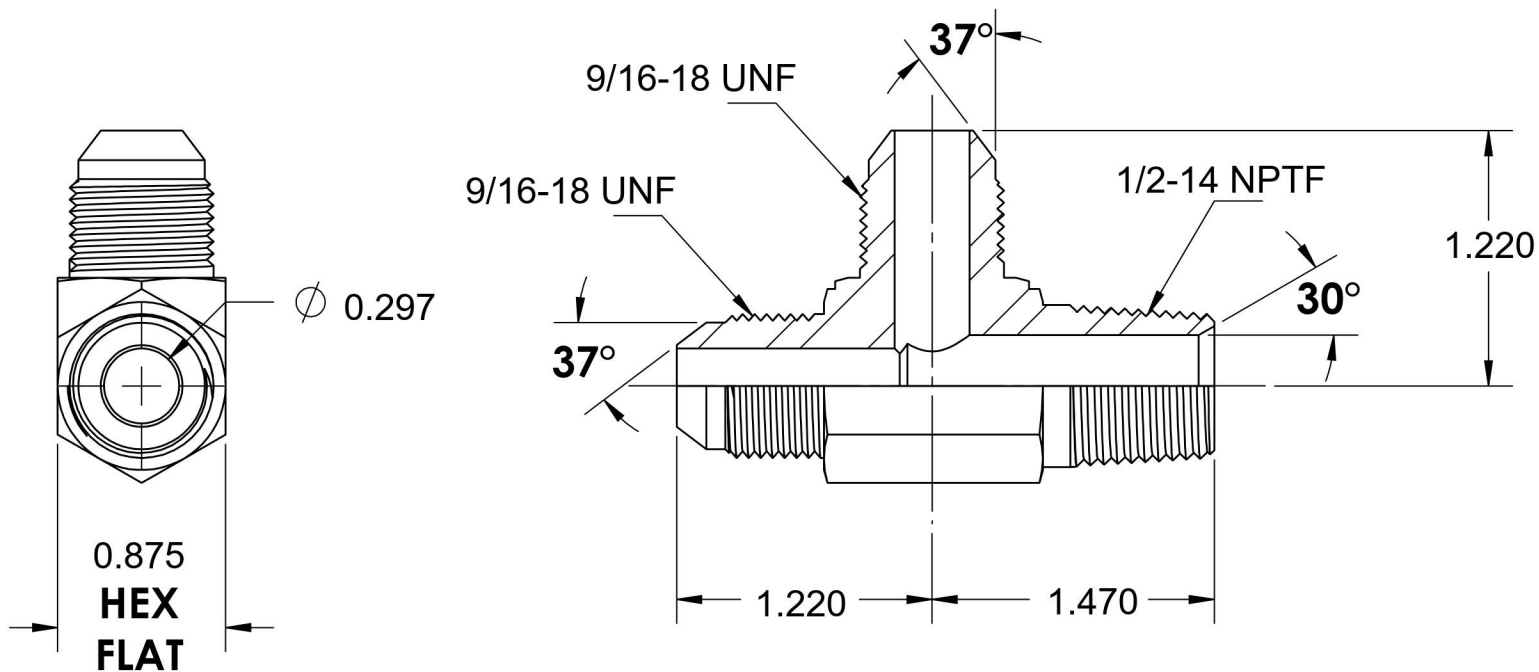
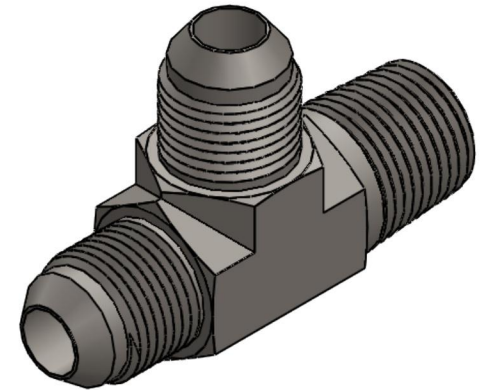
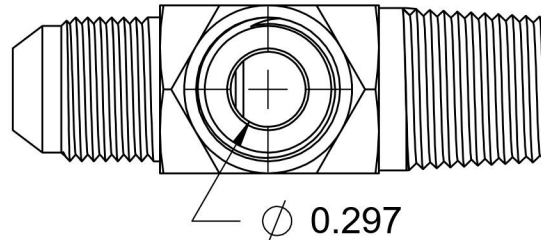

6701 Cochran Road
Solon, Ohio 44139
Phone: (440) 248-1880
Toll Free: 1-888-331-1523

Temperature Rating

-65°F to 500°F

Material

C1045 Steel

Industry Standards

SAE J514 , SAE J476
ASTM B633

Series

2605-FG

Pressure Rating

6000 psi

Finish

Trivalent Zinc

Series Description

SAE J514 37° Flare Male Run Tee