

6400-06-10-O

Steel, SAE J514 37° Flare Port Connector, 3/8" Male JIC x 7/8-14 Male ORB

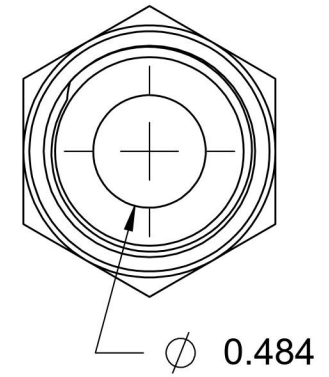
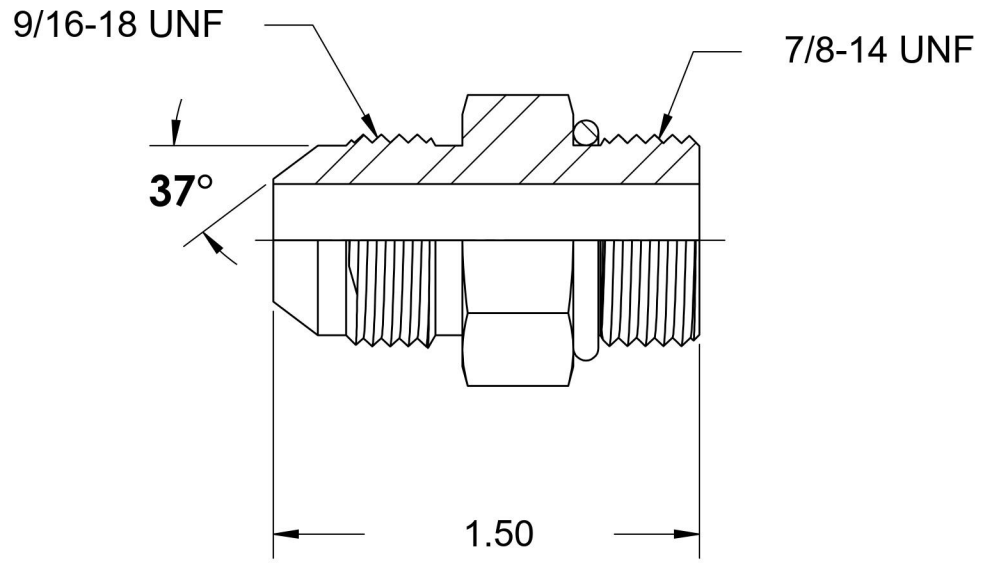
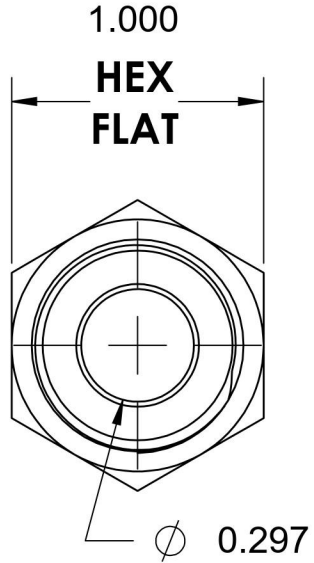

6701 Cochran Road
Solon, Ohio 44139
Phone: (440) 248-1880
Toll Free: 1-888-331-1523

Temperature Rating -40°F to 250°F	Material C1045 / 12L14 Steel	Industry Standards SAE J514, SAE J1926-3 ASTM B633	Series 6400-O
Pressure Rating 5000 psi	Finish Trivalent Zinc		Series Description SAE J514 37° Flare Port Connector