

# 7205-10-22-NWO-FG

Steel, SAE J514 37° Flare Male Metric Adjustable (Type H) Port 90° Elbow, 5/8" Male JIC x M22X1.5 Male Metric Adjustable ORR

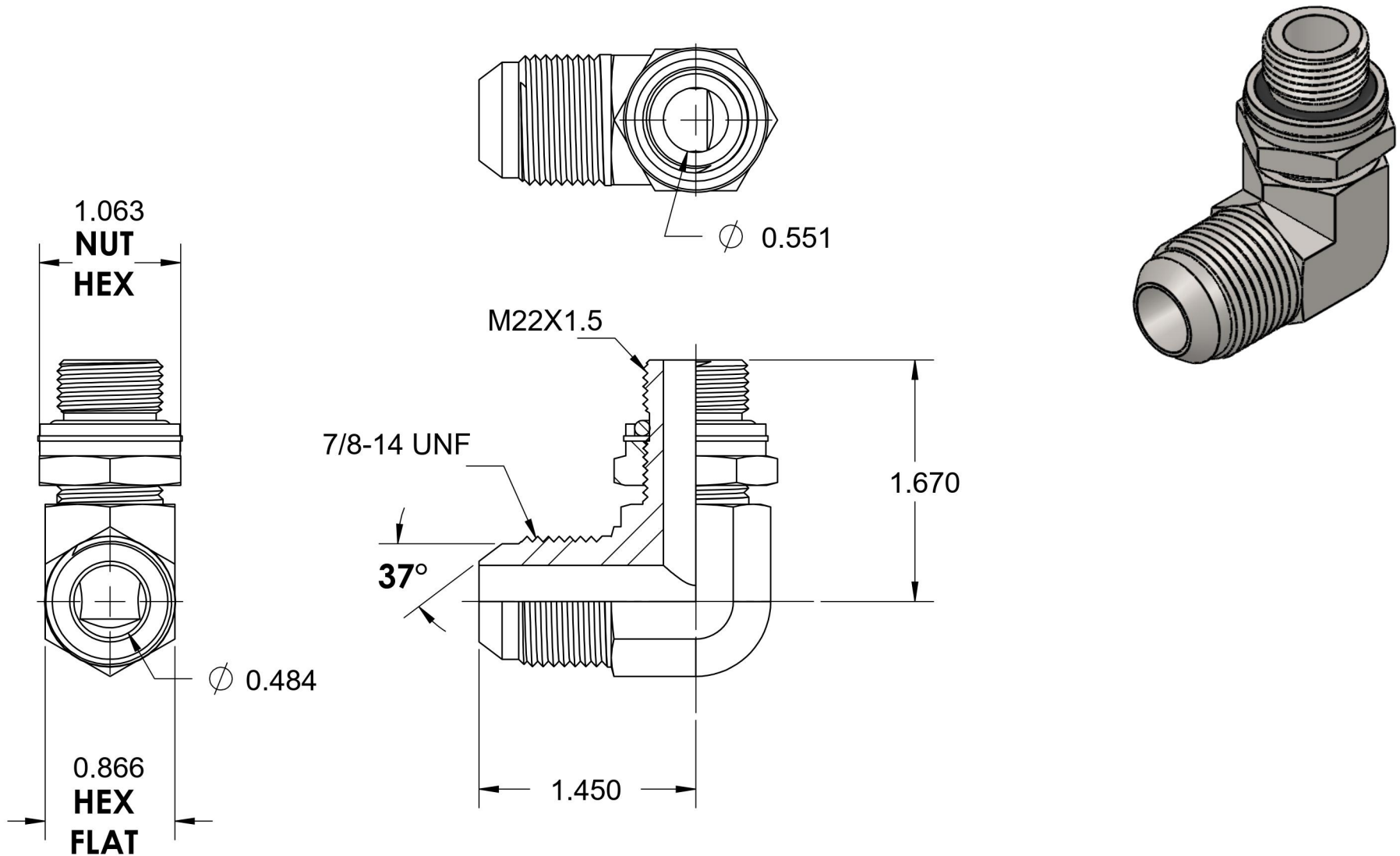

6701 Cochran Road  
Solon, Ohio 44139  
Phone: (440) 248-1880  
Toll Free: 1-888-331-1523

**Temperature Rating**

-40°F to 250°F

**Pressure Rating**

3600 psi

**Material**

C1045 Steel

**Finish**

Trivalent Zinc

**Industry Standards**

SAE J514, ISO 9974  
ASTM B633

**Series**

7205-NWO-FG-ORR

**Series Description**

SAE J514 37° Flare Male Metric Adjustable (Type H) Port 90° Elbow