

FS6504-08-12

Steel, SAE J1453 O-Ring Face Seal Swivel Adapter, 1/2" Female ORFS Swivel x 3/4" Male JIC

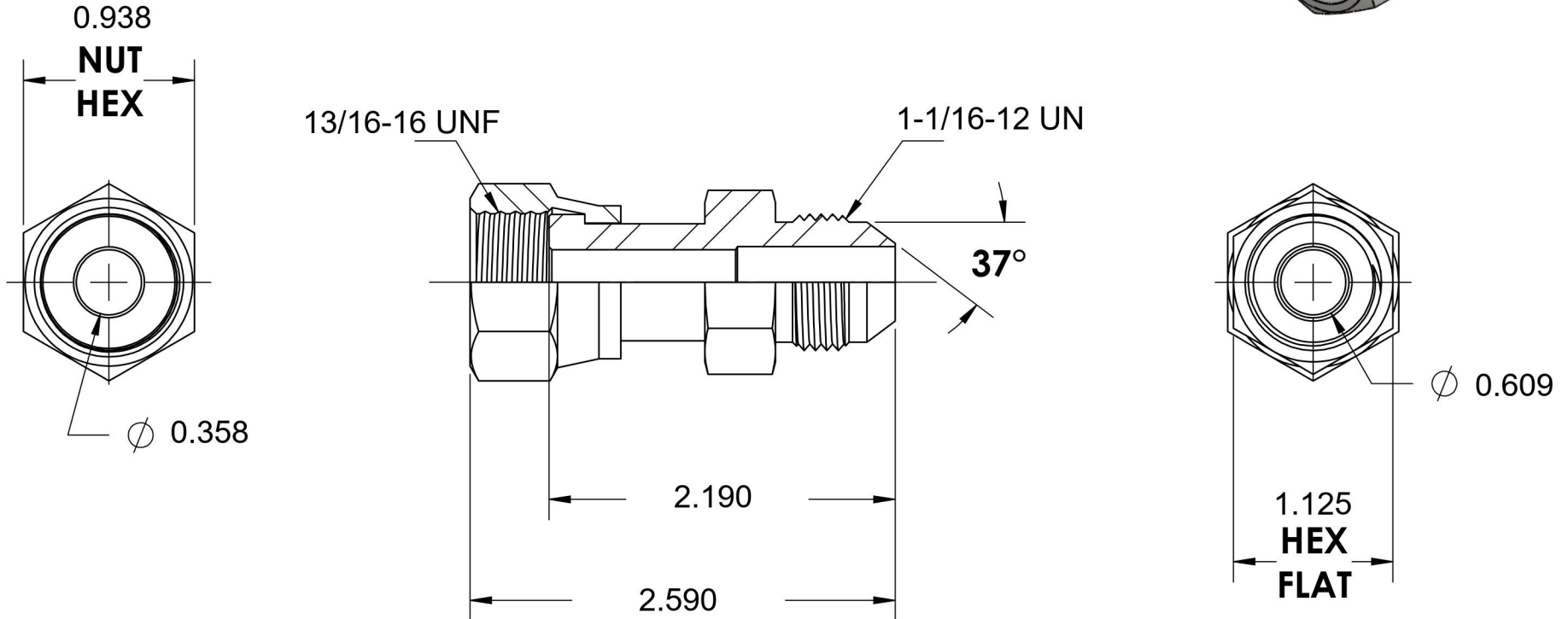
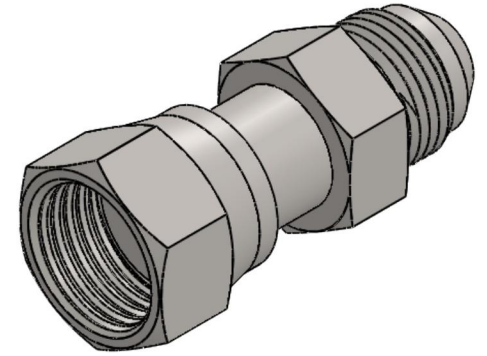

6701 Cochran Road
Solon, Ohio 44139
Phone: (440) 248-1880
Toll Free: 1-888-331-1523

Temperature Rating

-65°F to 500°F

Pressure Rating

5000 psi

Material

C1045/12L14 Steel

Finish

Trivalent Zinc

Industry Standards

SAE J1453, SAE J514
ASTM B633

Series

FS6504

Series Description

SAE J1453 O-Ring Face Seal Swivel Adapter