

7004-10-12

Steel, SAE J514 37° Flare BSPP Swivel Line Adapter, 5/8" Male JIC x 3/4-14 Female BSPP Swivel

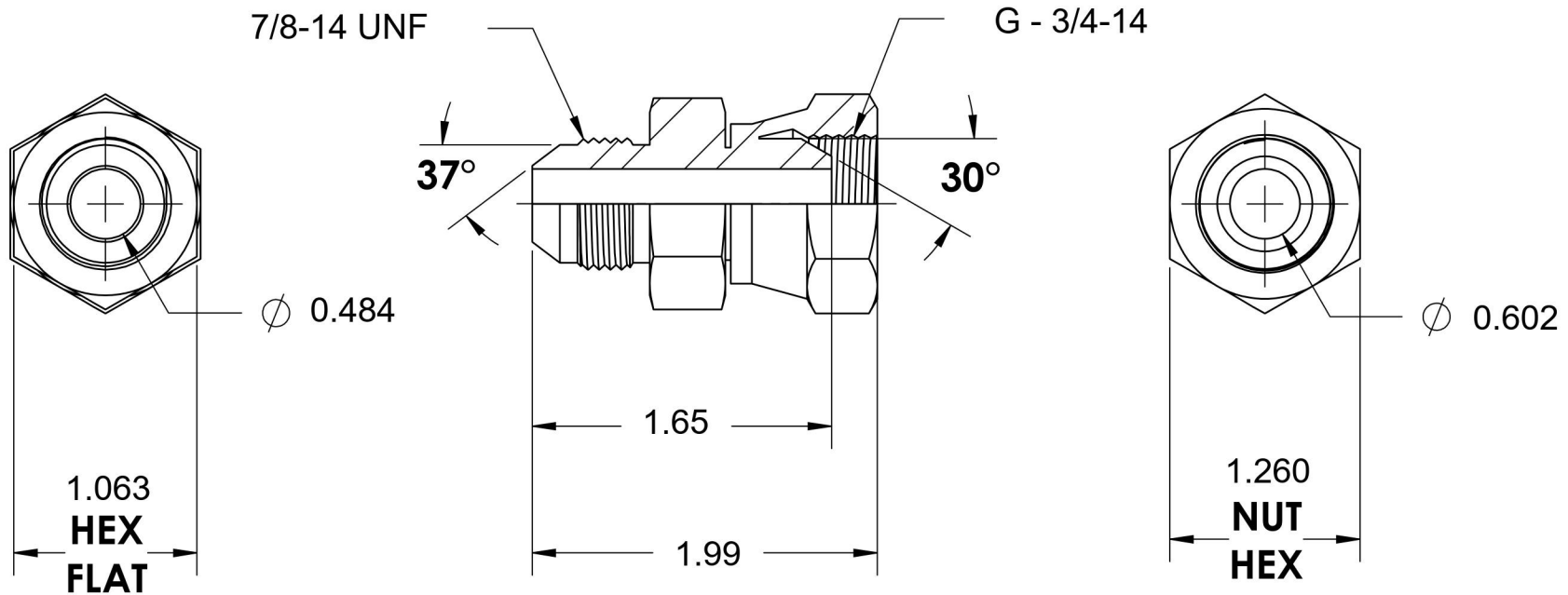
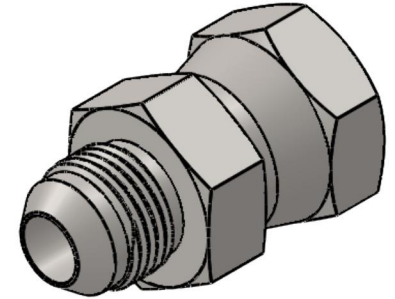

6701 Cochran Road
Solon, Ohio 44139
Phone: (440) 248-1880
Toll Free: 1-888-331-1523

Temperature Rating	Material	Industry Standards	Series
-65°F to 500°F	C1045 / 12L14 Steel	SAE J514, ISO 8434-6	7004
Pressure Rating	Finish	ASTM B633	Series Description
4000 psi	Trivalent Zinc		SAE J514 37° Flare BSPP Swivel Line Adapter