

5502-12-12-FG

Steel, SAE J514 Pipe 90° Street Elbow, 3/4" Male NPTF 30° x 3/4" Female NPTF

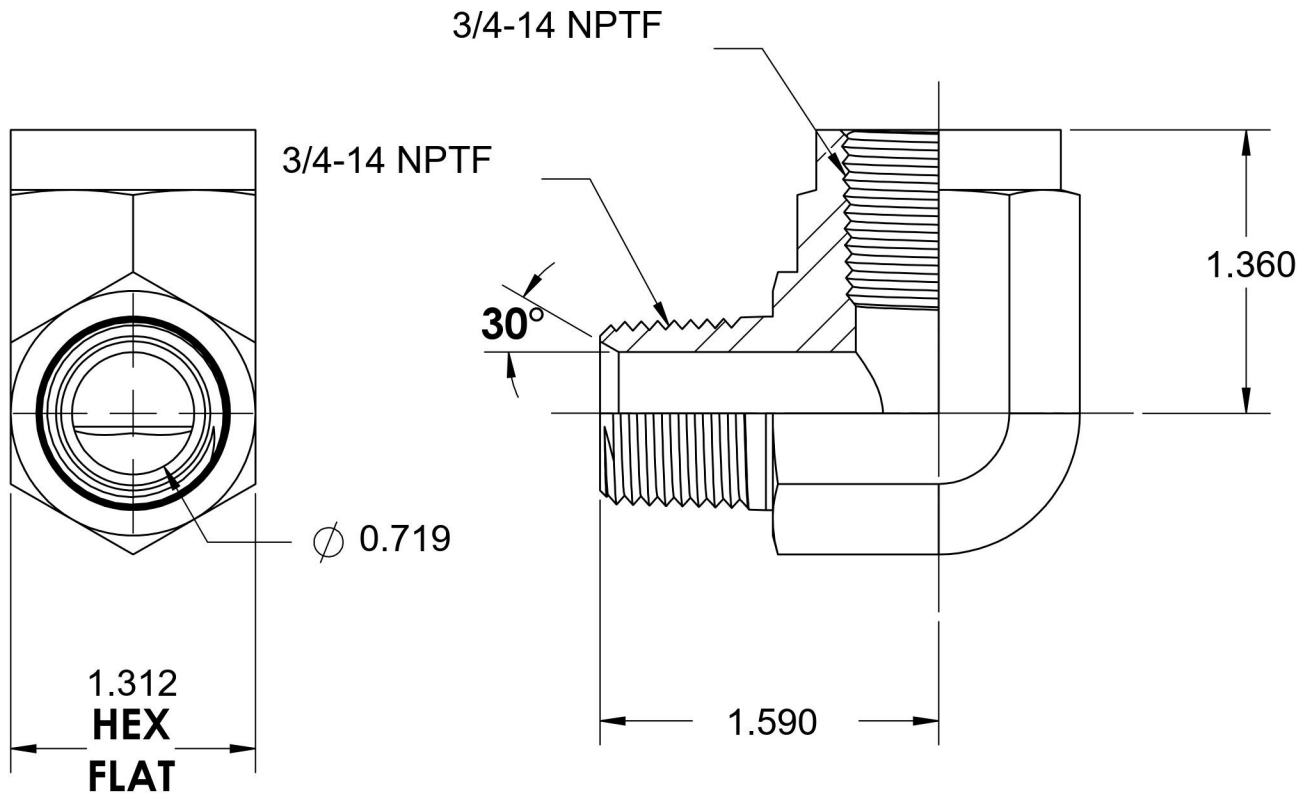

6701 Cochran Road
Solon, Ohio 44139
Phone: (440) 248-1880
Toll Free: 1-888-331-1523

Temperature Rating -65°F to 500°F	Material C1045 Steel	Industry Standards SAE J514 , SAE J476 ASTM B633	Series 5502-FG
Pressure Rating 3000 psi	Finish Trivalent Zinc		Series Description SAE J514 Pipe 90° Street Elbow