

FS6402-06-06

Steel, SAE J1453 O-Ring Face Seal Swivel Port Connector, 3/8" Male ORFS x 3/8" Female JIC Swivel

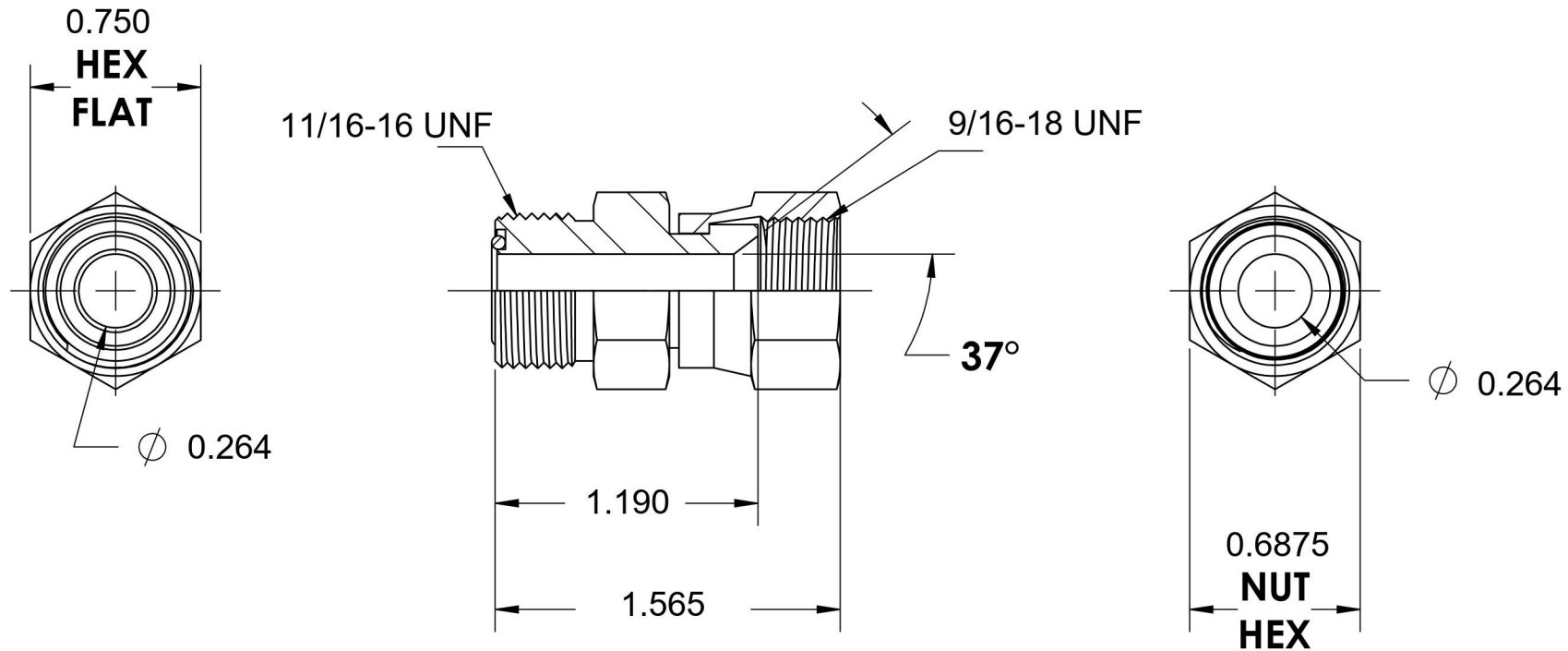
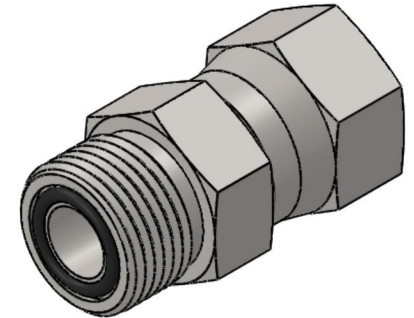

6701 Cochran Road
Solon, Ohio 44139
Phone: (440) 248-1880
Toll Free: 1-888-331-1523

Temperature Rating

-40°F to 250°F

Pressure Rating

5000 psi

Material

C1045/12L14 Steel

Finish

Trivalent Zinc

Industry Standards

SAE J1453, SAE J514
ASTM B633

Series

FS6402

Series Description

SAE J1453 O-Ring Face Seal
Swivel Port Connector