

FS6400-04-04-O-VITON

Steel, SAE J1453 O-Ring Face Seal Port Connector, 1/4" Male ORFS x 7/16-20 Male ORB, FKM Seal

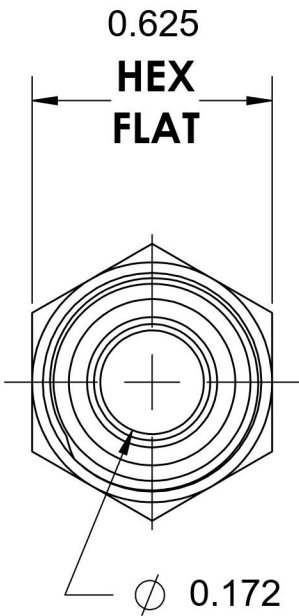

9/16-18 UNF

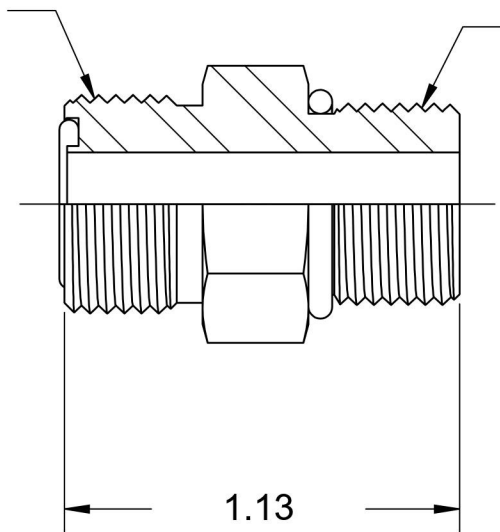

7/16-20 UNF

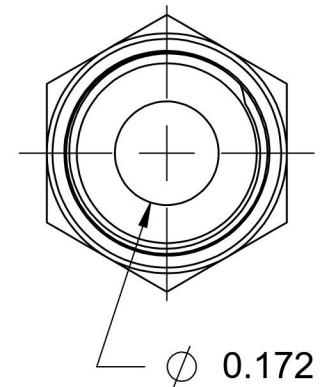

6701 Cochran Road
Solon, Ohio 44139
Phone: (440) 248-1880
Toll Free: 1-888-331-1523

Temperature Rating

-15°F to 400°F

Pressure Rating

9200 psi

Material

C1045 / 12L14 Steel

Finish

Trivalent Zinc

Industry Standards

SAE J1453, SAE J1926-2
ASTM B633

Series

FS6400-O-VITON

Series Description

SAE J1453 O-Ring Face Seal
Port Connector