

C0318-10-SS

Stainless Steel, SAE J514 Flareless Tube Nut, 5/8" Flareless Bite Type Nut

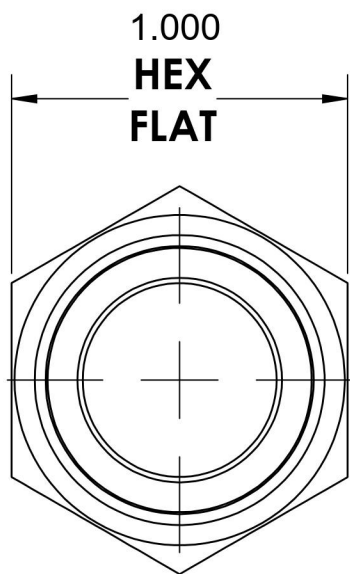

7/8-14 UNF

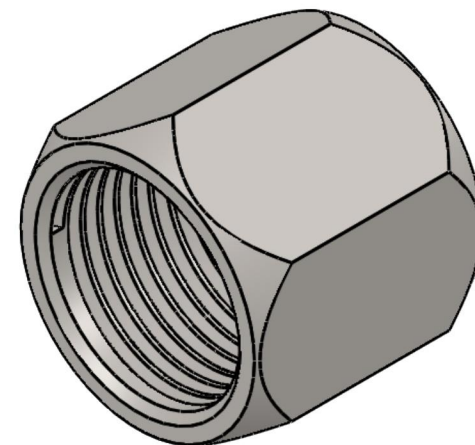
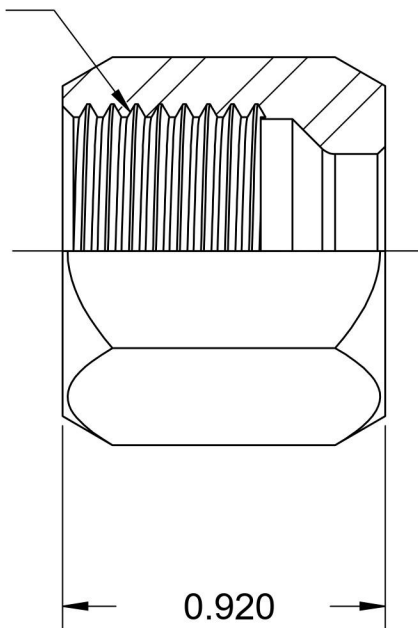

6701 Cochran Road
Solon, Ohio 44139
Phone: (440) 248-1880
Toll Free: 1-888-331-1523

Temperature Rating	Material	Industry Standards	Series
-425°F to 1200°F	316/316L Stainless	SAE J514	C0318
Pressure Rating	Finish		Series Description
Not Applicable	Passivation		SAE J514 Flareless Tube Nut