

2601-06-06-08-SS

Stainless Steel, SAE J514 SAE J514 37° Flare Male Branch Tee, 3/8" Male JIC x 3/8" Male JIC x 1/2" Male NPTF 30°

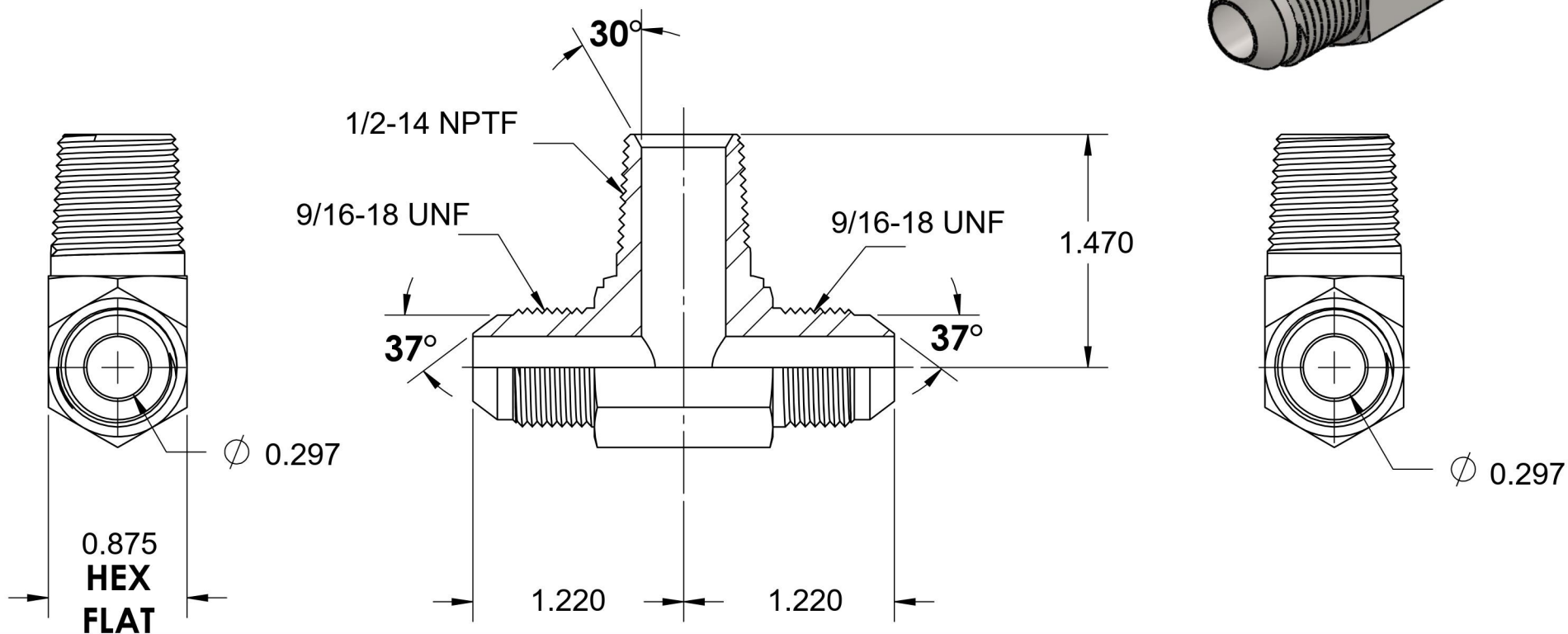
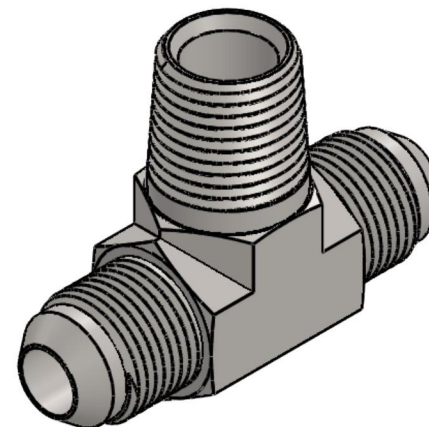
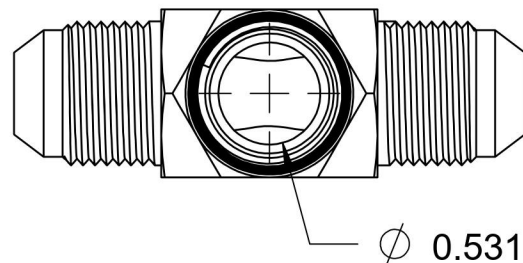

6701 Cochran Road
Solon, Ohio 44139
Phone: (440) 248-1880
Toll Free: 1-888-331-1523

| | | | |
|---------------------------|--------------------------|---------------------------|------------------------------------|
| Temperature Rating | Material | Industry Standards | Series |
| -425°F to 1200°F | 316/316L Stainless Steel | SAE J514 , SAE J476 | 2601-SS |
| Pressure Rating | Finish | | Series Description |
| 6000 psi | Passivated | | SAE J514 37° Flare Male Branch Tee |