

# 1502-08-04-FG

Steel, SAE J514 NPSM Swivel 90° Female Elbow, 1/2" Female NPTF x 1/4" Female NPSM Swivel

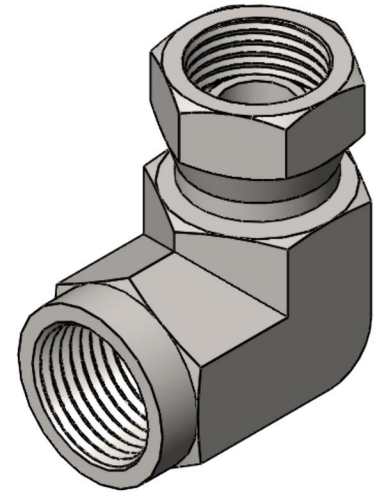
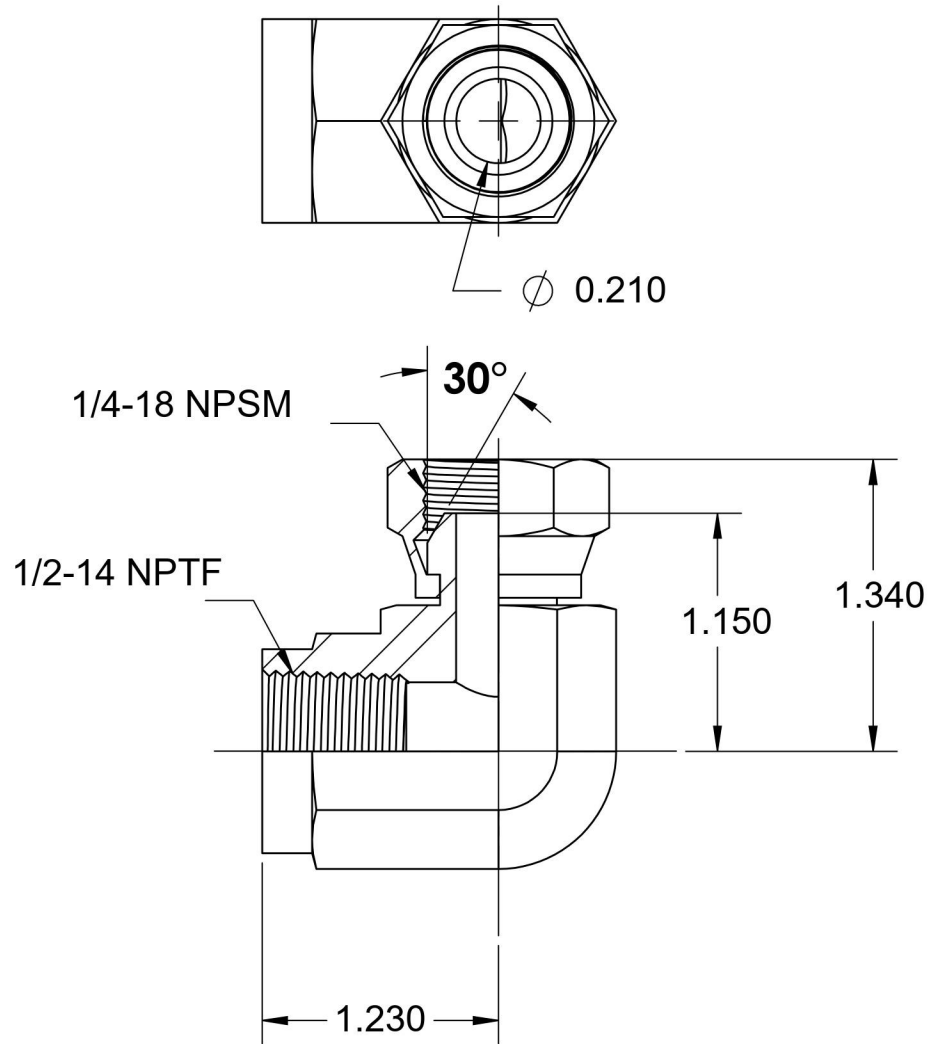
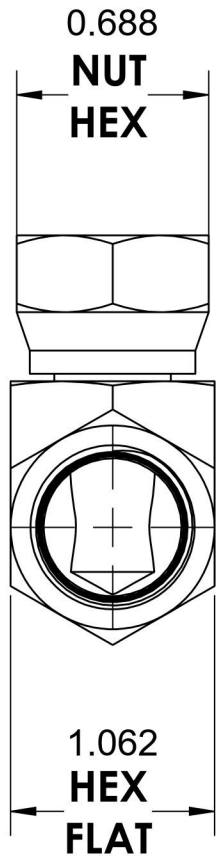

6701 Cochran Road  
Solon, Ohio 44139  
Phone: (440) 248-1880  
Toll Free: 1-888-331-1523

**Temperature Rating**

-65°F to 500°F

**Pressure Rating**

3000 psi

**Material**

C1045 Steel

**Finish**

Trivalent Zinc

**Industry Standards**

SAE J514, SAE J476  
ASTM B633

**Series**

1502-FG

**Series Description**

SAE J514 NPSM Swivel  
90° Female Elbow