

# 5504-06-04-FG

Steel, SAE J514 Pipe 90° Female Elbow, 3/8" Female NPTF x 1/4" Female NPTF

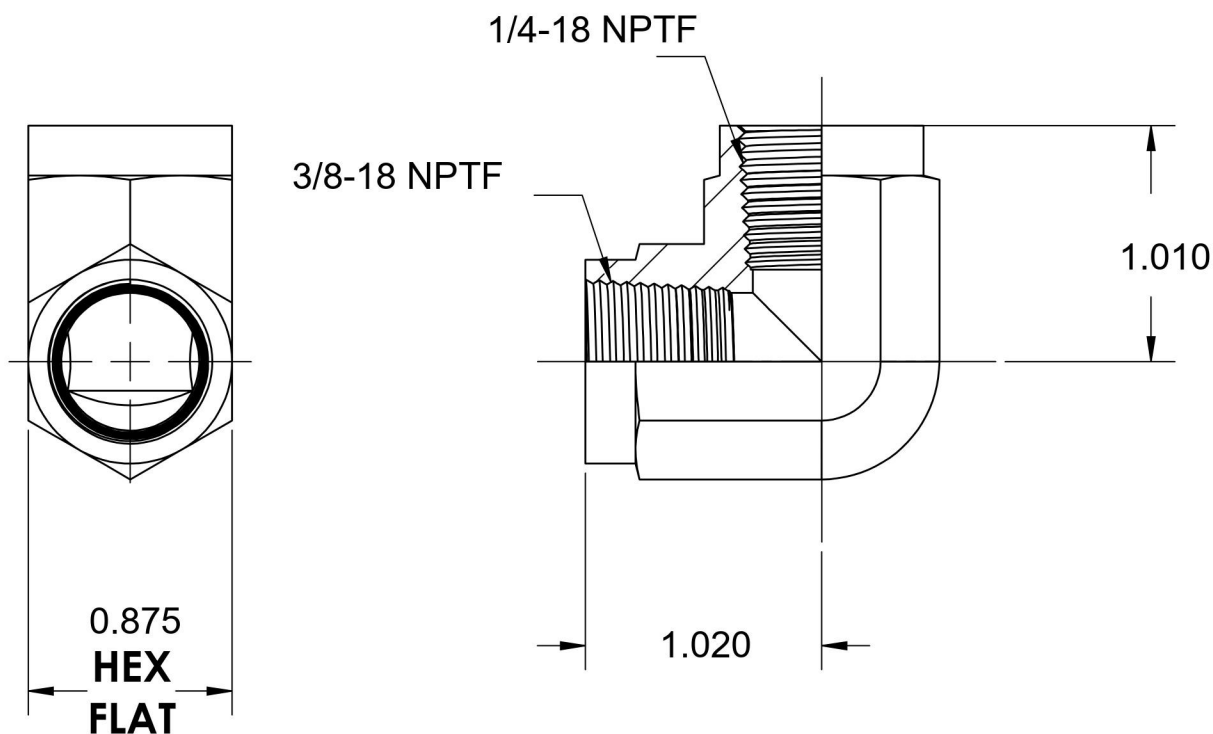

6701 Cochran Road  
Solon, Ohio 44139  
Phone: (440) 248-1880  
Toll Free: 1-888-331-1523

#### Temperature Rating

-65°F to 500°F

#### Pressure Rating

4500 psi

#### Material

C1045 Steel

#### Finish

Trivalent Zinc

#### Industry Standards

SAE J514, SAE J476  
ASTM B633

#### Series

5504-FG

#### Series Description

SAE J514 Pipe 90° Female Elbow