

# 6801-12-24-NWO-SS

Stainless Steel, SAE J514 37° Flare 90° Adjustable Port Elbow, 3/4" Male JIC x 1-7/8-12 Male Adjustable ORB

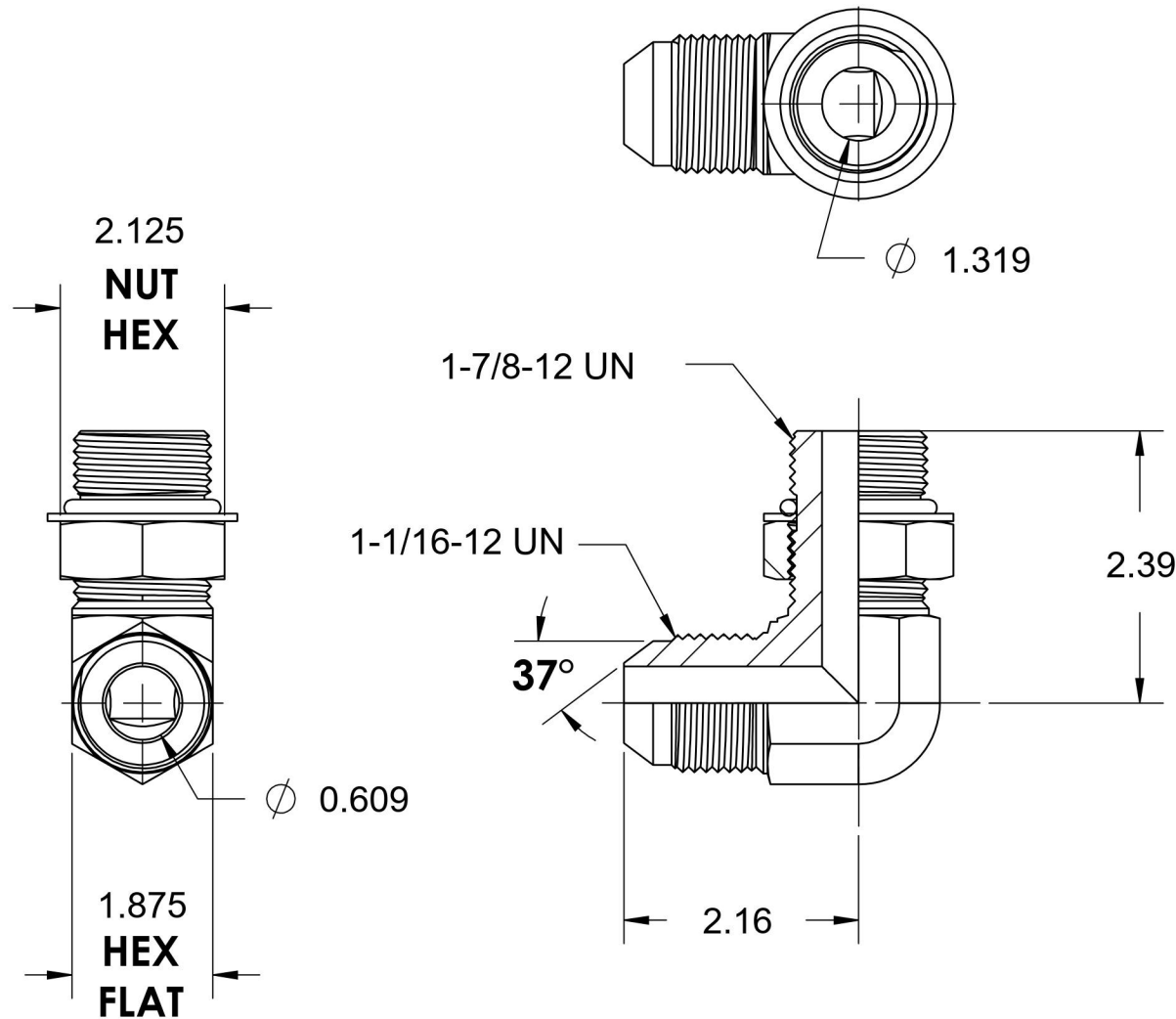

6701 Cochran Road  
Solon, Ohio 44139  
Phone: (440) 248-1880  
Toll Free: 1-888-331-1523

<b>Temperature Rating</b>	<b>Material</b>	<b>Industry Standards</b>	<b>Series</b>
-40°F / 250°F	316/316L Stainless Steel	SAE J514, SAE J1926-3	6801-NWO-SS
<b>Pressure Rating</b>	<b>Finish</b>		<b>Series Description</b>
2500 psi	Passivated		SAE J514 37° Flare 90° Adjustable Port Elbow