

D0304-C-S20-SS

Stainless Steel, DIN 2353 Blanking Plug, Heavy 20mm Tube OD

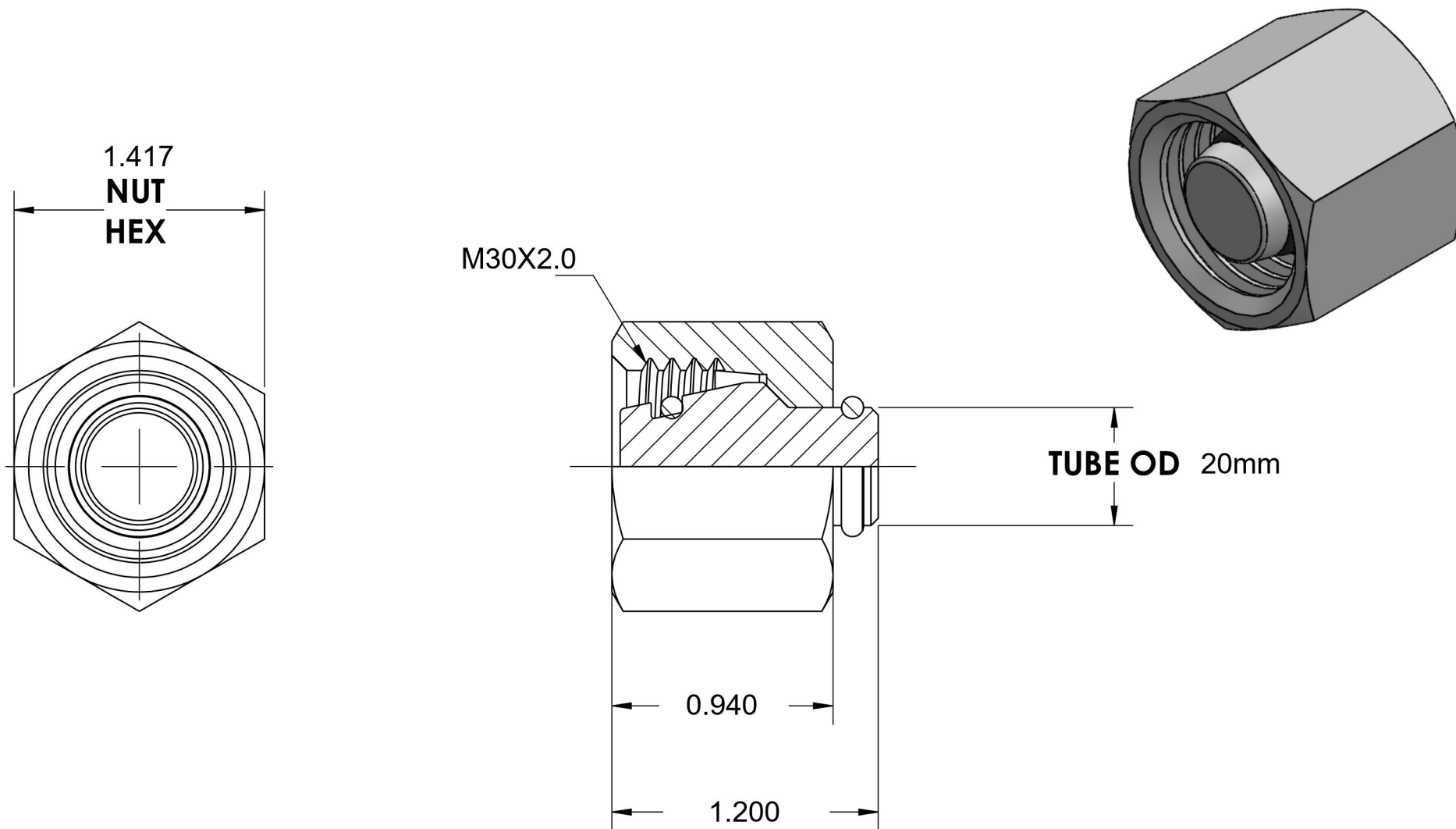

6701 Cochran Road
Solon, Ohio 44139
Phone: (440) 248-1880
Toll Free: 1-888-331-1523

Temperature Rating -15°F to 400°F	Material 316Ti Stainless Steel	Industry Standards DIN 2353, ISO 8434-1	Series D0304-C-SS
Pressure Rating Not Available	Finish Passivated		Series Description DIN 2353 Flareless Tube Blanking Cap Assembly